

ALL OPERATIONS MUST BE CARRIED OUT BY QUALIFIED PERSON

- ① Unscrew the four screws under the base.
Lift the structure separating it from the base.

Svitare le quattro viti posizionate sotto la base.
Sollevare la struttura separandola dalla base.

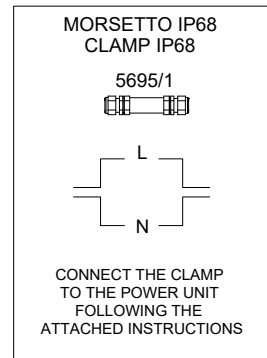
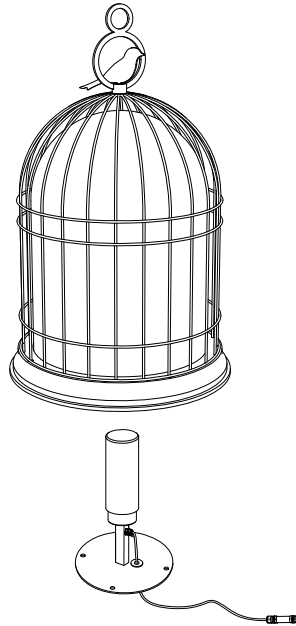
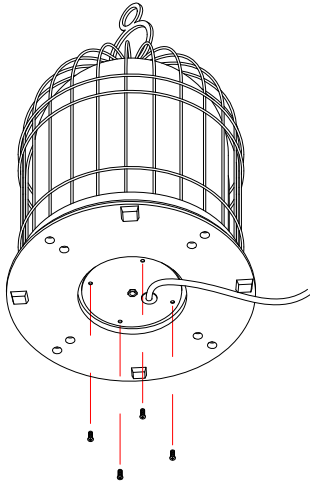

- ② During the assembly, or when replacing a bulb verify the presence of the gasket (O-RING) between the ring nut and the glass.
Insert the glass up to the bottom.
WARNING! Thread the glass by applying pressure and not by rotation.
If the glass or the gasket are damaged, do not connect the power unit and replace them.

Nel montaggio o nella sostituzione della lampadina verificare sempre la presenza della guarnizione (O-RING) tra ghiera e vetro.

Inserire il vetro infilandolo fino in fondo.
ATTENZIONE! Infilare il vetro applicando una pressione e non ruotandolo.
Se il vetro o la guarnizione risultassero danneggiati non collegare l'alimentazione e sostituirli.

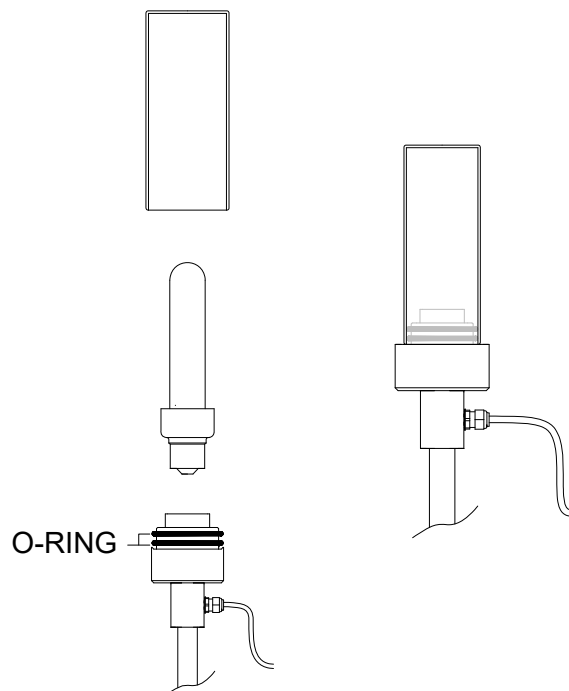

M682-B IP68 Waterproof Connector

Connettore impermeabile M682-B IP68



INSTALLING INSTRUCTIONS

Pag. 1/2

DRAWN BY

N.O.

ALL OPERATIONS MUST BE CARRIED OUT BY QUALIFIED PERSON

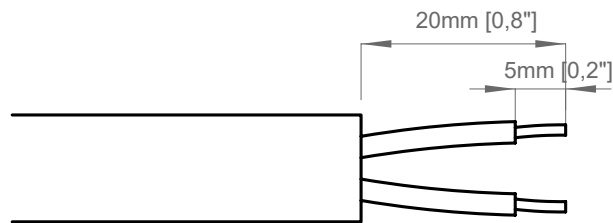
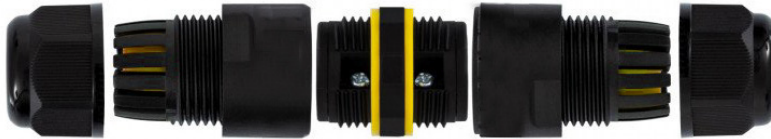

- ① Prepare terminal connector and two wires, wires need split 2" and remove 1/2" of jacket.

Preparare il connettore terminale e i due fili, i fili devono essere scoperti 50mm circa e rimuovere 15mm dal rivestimento dei cavi.

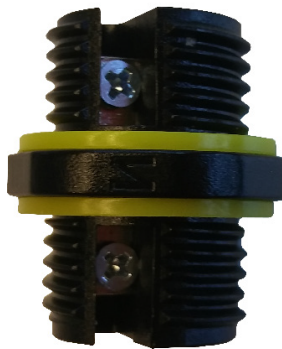

- ② Back out the screws in terminal block a little to ensure following easy connection.

Allentare leggermente le viti nella morsettiera per garantire una facile connessione.

M682-B IP68 Waterproof Connector

Connettore impermeabile M682-B IP68



INSTALLING INSTRUCTIONS

Pag. 2/2

DRAWN BY

N.O.

ALL OPERATIONS MUST BE CARRIED OUT BY QUALIFIED PERSON



- ③ Plug the wires into the terminal block and screw tighten, please make sure the color of wires matches the picture.

Inserire i fili nella morsettiera e serrare a fondo, assicurarsi che il colore dei fili sia corrispondente all'immagine.



- ④ Twist and tighten the cable glands.

Serrare i fermacavi.