

DRESS_CODE INDOOR

Design gumdesign

S•CAB

art. 2582 GLAM

lounge armchair / chaise-longue

art. 2580 SMART

lounge armchair / chaise-longue



La nuova seduta DRESS_CODE si ispira ai canoni della moda sartoriale, giocando con gli abbinamenti di colori, tra struttura e seduta, con le trame dei tessuti per indoor ed outdoor e con la loro lavorazione: oltre al tessuto liscio come un foglio, viene proposta una versione trapuntata a quadrotti. Le trapuntature e le imbottiture sono sia un elemento grafico che fonte di maggiore comfort. Disponibile come accessorio un cuscino poggiatesta rivestito anch'esso in tessuto.

The new DRESS_CODE lounge armchair is inspired by the canons of haute couture, playing with the combinations of colours between structure and seat, with the indoor and outdoor fabrics patterns, and with their upholstery: in addition to the smooth and flat fabric version, there is a quilted version in big squares. The quilting and padding are both an aesthetic element and a source of greater comfort. A headrest cushion is available as an accessory, also with a fabric cover.

La nouvelle chaise-longue DRESS_CODE s'inspire des normes de la mode vestimentaire, en jouant avec les associations de couleurs, entre structure et assise, avec les tissus pour intérieur et extérieur et avec leur fabrication : en plus du tissu lisse comme une feuille, il existe une version capitonnée carrés. Le capitonnage et le rembourrage sont un élément graphique mais qui offre aussi un plus grand confort. Un coussin appui-tête en tissu est également disponible en option.

TELAIO FRAME CHÂSSIS

Struttura in acciaio tubolare Ø 16 mm
Tubular steel structure Ø 16 mm
Structure en acier tubulaire Ø 16 mm

FINITURE FINISHES FINITIONS



BRACCIOLO Ø 40 mm ARMREST Ø 40 mm ACCOUDOIR Ø 40 mm

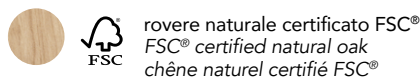

TELO TESSUTO FABRIC CLOTH TOILE EN TISSU



TELO TESSUTO FABRIC CLOTH TOILE EN TISSU

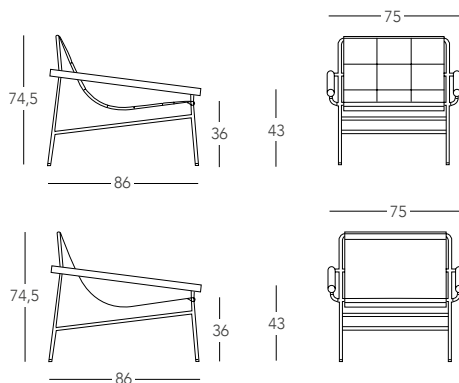
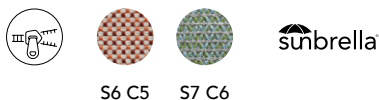

ART. 2582 GLAM

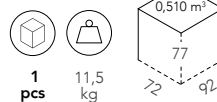

ART. 2580 SMART

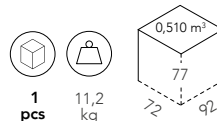

S•CAB

Made in Italy — s-cab.it

SEDE/HEADQUARTERS
Via G. Monauni, 12
25030 Coccaglio (BS) Italy

DIVISIONE COMMERCIALE ITALIA
Ph +39 030 7718.760/765/770/775
e-mail: italia@s-cab.it

EXPORT DEPARTMENT
Ph +39 030 7718.715/720/725/726
e-mail: export@s-cab.it

TELO DI RICAMBIO
SPARE CLOTH
TOILE DE RECHANGE

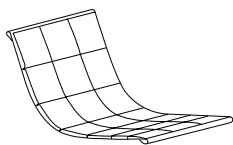

ART. 1603

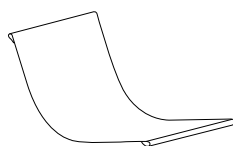
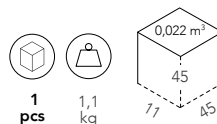

ART. 1602

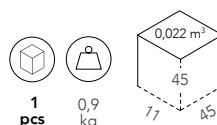

CERTIFICAZIONI
CERTIFICATIONS
CERTIFICATIONS



Conforme / Compliant with / Conforme à
EN 16139:2013



Prodotto certificato FSC® – Prodotto realizzato con legno certificato proveniente da foreste gestite in modo corretto e responsabile
FSC® certified article – The product is manufactured with wood supplied with origin certification from well- and responsibly managed forests.
Produit certifié FSC® – Produit réalisé avec du bois certifié provenant de forêts gérées de manière correcte et responsable.

PREMI
AWARDS
PRIX



WINNER

Prodotto 100% disassemblabile per un corretto processo di riciclo.
100% demountable item for a correct recycling process.
Produit 100 % démontable pour un recyclage correct.